

Multi-Trans Industrieanhänger PA 65-2 (60t, 6000x 2500mm)

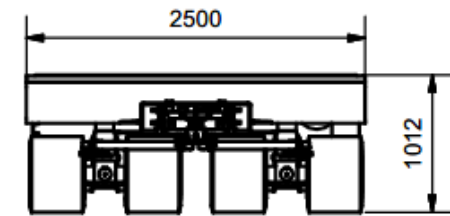

Nutzlast 60t

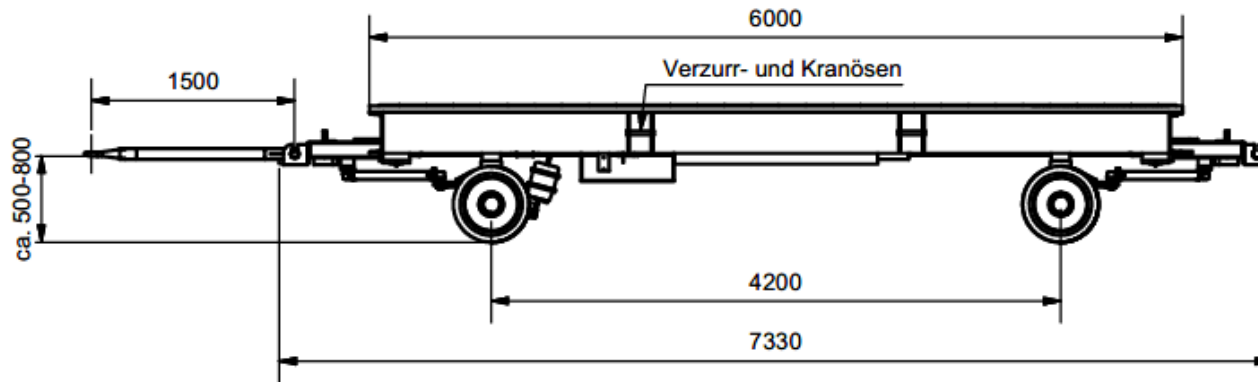